

| | |
|-----------|-------|
| PROJECT | _____ |
| TYPE | _____ |
| SPECIFIER | _____ |
| QUANTITY | _____ |
| DATE | _____ |

METROPOLIS MONOPOINT HALO SUSPENSION

D201032-

| | | | | | |
|-------------|----------------------|---------------------|----------------------|-----------------|------------------|
| base number | Color Temperature | Finish (Diamond) | Finish (Triangle) | Lens Options | Cable Options |
|-------------|----------------------|---------------------|----------------------|-----------------|------------------|

- To build a product code in our configurator select the specify button on the base model # product page
- To build a manual product code on this datasheet choose from the options listed below in blue font and add the suffix to the base model #

GENERAL

| |
|--------------------------------------|
| Series: Metropolis |
| Subseries: Metropolis Monopoint Halo |
| Partner: Zaneen |
| Division: Design |
| Installation: Suspension |
| Product Type: Pendant |
| Mounting Location: Ceiling |
| Light Distribution: Downlight |

PHYSICAL

| |
|--|
| Shape: Cylinder |
| Diameter (mm): 25 |
| Diameter (in): 1 |
| Height (mm): 520 |
| Height (in): 20 1/2 |
| Fixture Finish: BLK / BRZ / IND |
| Holder Finish: BLK / BRZ / IND / WHI |
| Fixture Material: Aluminum |
| Cable Details: Black or Transparent - 3500mm / 137 13/16" |
| Upon Request: Cylinder height. Max. 1830 mm / 72". Min 153mm / 6". Min. qty required 50 pcs. |

ELECTRICAL

| |
|---|
| Lamp Type: LED |
| Input Wattage (W): 3.65 |
| Total Output Wattage (W): 2.7 |
| Dimming: Non-Dimmable |
| Driver Included: Yes |
| Driver Location: Integrated |
| Driver Type: Constant Current - Universal |
| Driver Class: Class 2 |
| Input Voltage (V): 120 - 277 |
| Constant Current (MA): 700 |
| Upon Request: Remote: Phase dimming @120Vac only / 0-10Vdc dimming (dimming requires min. 3 fixtures) |

LED

| |
|---|
| Number of LEDs: 1 |
| Color Temperature (°K): 3000 / 4000 |
| Max. Delivered Lumen (lm): 114 / 122 |
| Nominal Lumen (lm): 124 / 133 |
| CRI: >90 CRI |
| Lamp Life (hrs): 50000 |
| Upon Request: 3500K |

OPTICAL

| |
|---------------------------------------|
| Optic°: 12 / 28 / 44 |
| Upon Request: Damp Rated for Exterior |

RATINGS AND CERTIFICATIONS

| |
|--|
| Certified By: Certified for North American Standards |
| IP rating: IP41 (Damp) |

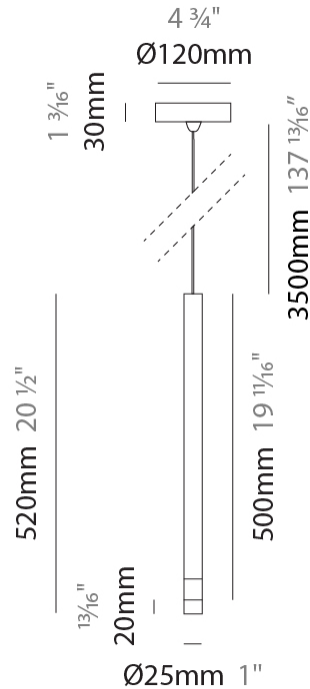

METROPOLIS MONOPOINT HALO SUSPENSION

D201032-

PROJECT _____

TYPE _____

SPECIFIER _____

QUANTITY _____

DATE _____

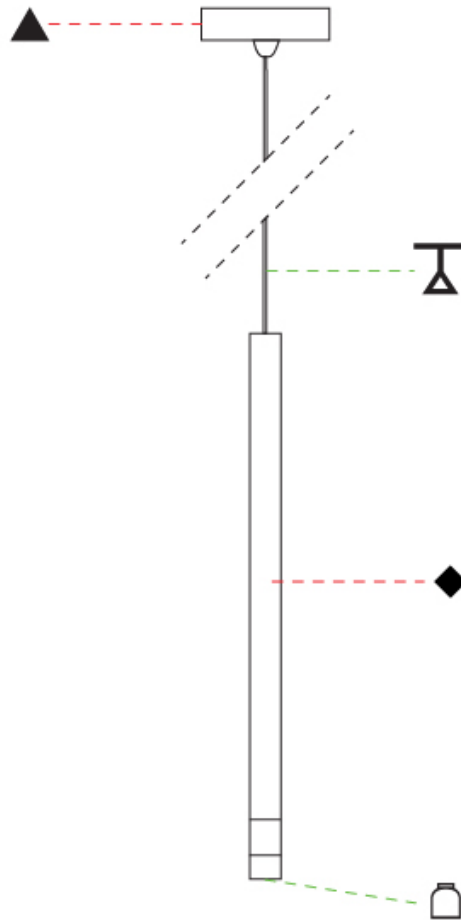

D

| | |
|-----------|-------|
| PROJECT | _____ |
| TYPE | _____ |
| SPECIFIER | _____ |
| QUANTITY | _____ |
| DATE | _____ |

METROPOLIS MONOPOINT HALO SUSPENSION

D201033-

| | | | | | |
|-------------|----------------------|---------------------|----------------------|-----------------|------------------|
| base number | Color Temperature | Finish (Diamond) | Finish (Triangle) | Lens Options | Cable Options |
|-------------|----------------------|---------------------|----------------------|-----------------|------------------|

- To build a product code in our configurator select the specify button on the base model # product page
- To build a manual product code on this datasheet choose from the options listed below in blue font and add the suffix to the base model #

GENERAL

| |
|--------------------------------------|
| Series: Metropolis |
| Subseries: Metropolis Monopoint Halo |
| Partner: Zaneen |
| Division: Design |
| Installation: Suspension |
| Product Type: Pendant |
| Mounting Location: Ceiling |
| Light Distribution: Downlight |

PHYSICAL

| |
|--|
| Shape: Cylinder |
| Diameter (mm): 26 |
| Diameter (in): 1 |
| Height (mm): 820 |
| Height (in): 32 5/16 |
| Fixture Finish: BLK / BRZ / IND |
| Holder Finish: BLK / BRZ / IND / WHI |
| Fixture Material: Aluminum |
| Cable Details: Black or Transparent - 3500mm / 137 13/16" |
| Upon Request: Cylinder height. Max. 1830 mm / 72". Min 153mm / 6". Min. qty required 50 pcs. |

ELECTRICAL

| |
|---|
| Lamp Type: LED |
| Input Wattage (W): 3.65 |
| Total Output Wattage (W): 2.7 |
| Dimming: Non-Dimmable |
| Driver Included: Yes |
| Driver Location: Integrated |
| Driver Type: Constant Current - Universal |
| Driver Class: Class 2 |
| Input Voltage (V): 120 - 277 |
| Constant Current (MA): 700 |
| Upon Request: Remote: Phase dimming @120Vac only / 0-10Vdc dimming (dimming requires min. 3 fixtures) |

LED

| |
|---|
| Number of LEDs: 1 |
| Color Temperature (°K): 3000 / 4000 |
| Max. Delivered Lumen (lm): 114 / 122 |
| Nominal Lumen (lm): 124 / 133 |
| CRI: >90 CRI |
| Lamp Life (hrs): 50000 |
| Upon Request: 3500K |

OPTICAL

| |
|--|
| Optic°: 12 / 28 / 44 |
|--|

RATINGS AND CERTIFICATIONS

| |
|--|
| Certified By: Certified for North American Standards |
| IP rating: IP41 (Damp) |
| Upon Request: Damp Rated for Exterior |

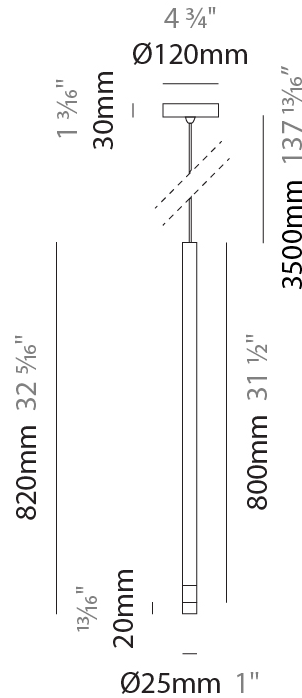

METROPOLIS MONOPOINT HALO SUSPENSION

D201033-

| |
|-----------|
| PROJECT |
| TYPE |
| SPECIFIER |
| QUANTITY |
| DATE |

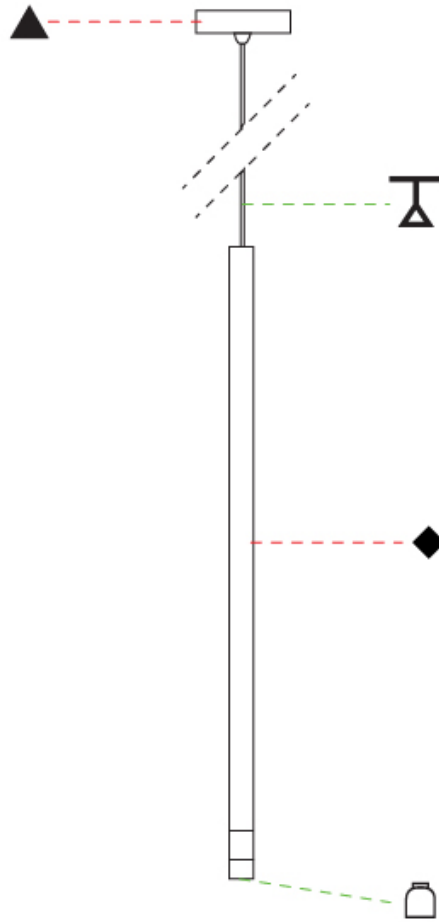

D

METROPOLIS MONOPOINT HALO SURFACE

D202002-

base number Color Finish Finish Lens
 Temperature (Diamond) (Triangle) Options

- To build a product code in our configurator select the specify button on the base model # product page
- To build a manual product code on this datasheet choose from the options listed below in blue font and add the suffix to the base model #

GENERAL

Series: Metropolis
 Subseries: Metropolis Monopoint Halo
 Partner: Zaneen
 Division: Design
 Installation: Surface
 Product Type: Ceiling Surface
 Mounting Location: Ceiling
 Light Distribution: Downlight

PHYSICAL

Aperture Sizes - Downlights: 1"
 Shape: Cylinder
 Diameter (mm): 120
 Diameter (in): 4 3/4
 Height (mm): 520
 Height (in): 20 1/2
 Fixture Finish: [BLK / BRZ / IND](#)
 Holder Finish: [BLK / BRZ / IND / WHI](#)
 Fixture Material: Aluminum
 Upon Request: Cylinder height. Max. 1830 mm / 72". Min 153mm / 6".
 Min. qty required 50 pcs.

ELECTRICAL

Lamp Type: LED
 Input Wattage (W): 3.65
 Total Output Wattage (W): 2.7
 Dimming: Non-Dimmable
 Driver Included: Yes
 Driver Location: Integrated
 Driver Type: Constant Current - Universal
 Driver Class: Class 2
 Input Voltage (V): 120 - 277
 Constant Current (MA): 700
 Upon Request: (Not included - see components) Remote: Phase dimming @120Vac only / 0-10Vdc dimming (dimming requires min. 3 fixtures)

LED

Number of LEDs: 1
 Color Temperature (°K): [3000 / 4000](#)
 Nominal Lumen (lm): 124 / 133
 CRI: >90 CRI
 Lamp Life (hrs): 50000
 Upon Request: 3500K

OPTICAL

Optic°: [12 / 28 / 44](#)

RATINGS AND CERTIFICATIONS

Certified By: Certified for North American Standards
 IP rating: IP41 (Damp)
 Upon Request: Damp Rated for Exterior

| |
|-----------|
| PROJECT |
| TYPE |
| SPECIFIER |
| QUANTITY |
| DATE |

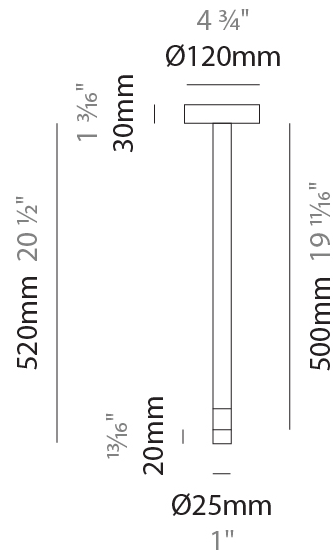

METROPOLIS MONOPOINT HALO SURFACE

D202002-

PROJECT

TYPE

SPECIFIER

QUANTITY

DATE

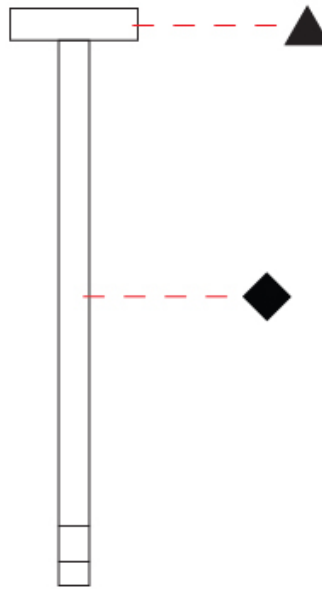

D

METROPOLIS MONOPOINT HALO SURFACE

D202003-

base number Color Finish Finish Lens
 Temperature (Diamond) (Triangle) Options

- To build a product code in our configurator select the specify button on the base model # product page
- To build a manual product code on this datasheet choose from the options listed below in blue font and add the suffix to the base model #

GENERAL

Series: Metropolis
 Subseries: Metropolis Monopoint Halo
 Partner: Zaneen
 Division: Design
 Installation: Surface
 Product Type: Ceiling Surface
 Mounting Location: Ceiling
 Light Distribution: Downlight

PHYSICAL

Aperture Sizes - Downlights: 1"
 Shape: Cylinder
 Diameter (mm): 120
 Diameter (in): 4 3/4
 Height (mm): 820
 Height (in): 32 5/16
 Fixture Finish: [BLK / BRZ / IND](#)
 Holder Finish: [BLK / BRZ / IND / WHI](#)
 Fixture Material: Aluminum
 Upon Request: Cylinder height. Max. 1830 mm / 72". Min 153mm / 6".
 Min. qty required 50 pcs.

ELECTRICAL

Lamp Type: LED
 Input Wattage (W): 3.65
 Total Output Wattage (W): 2.7
 Dimming: Non-Dimmable
 Driver Included: Yes
 Driver Location: Integrated
 Driver Type: Constant Current - Universal
 Driver Class: Class 2
 Input Voltage (V): 120 - 277
 Constant Current (MA): 700
 Upon Request: (Not included - see components) Remote: Phase dimming @120Vac only / 0-10Vdc dimming (dimming requires min. 3 fixtures)

LED

Number of LEDs: 1
 Color Temperature (°K): [3000 / 4000](#)
 Nominal Lumen (lm): 124 / 133
 CRI: >90 CRI
 Lamp Life (hrs): 50000
 Upon Request: 3500K

OPTICAL

Optic°: [12 / 28 / 44](#)

RATINGS AND CERTIFICATIONS

Certified By: Certified for North American Standards
 IP rating: IP41 (Damp)
 Upon Request: Damp Rated for Exterior

| |
|-----------|
| PROJECT |
| TYPE |
| SPECIFIER |
| QUANTITY |
| DATE |

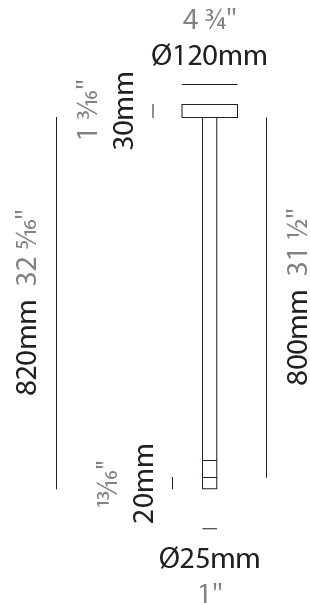

METROPOLIS MONOPOINT HALO SURFACE

D202003-

PROJECT

TYPE

SPECIFIER

QUANTITY

DATE

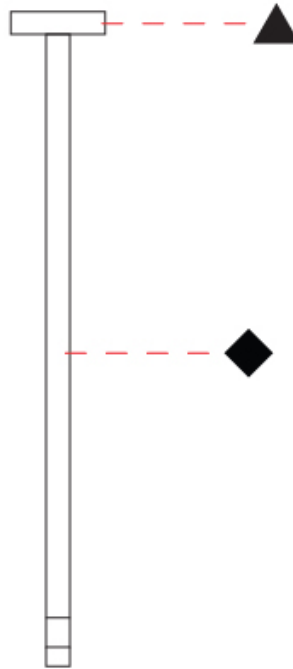

D

| | |
|-----------|--|
| PROJECT | |
| TYPE | |
| SPECIFIER | |
| QUANTITY | |
| DATE | |

METROPOLIS MONOPOINT HALO SURFACE

D202006-

| | | | | |
|-------------|----------------------|---------------------|----------------------|-----------------|
| base number | Color Temperature | Finish (Diamond) | Finish (Triangle) | Lens Options |
|-------------|----------------------|---------------------|----------------------|-----------------|

- To build a product code in our configurator select the specify button on the base model # product page
- To build a manual product code on this datasheet choose from the options listed below in blue font and add the suffix to the base model #

GENERAL

| |
|--------------------------------------|
| Series: Metropolis |
| Subseries: Metropolis Monopoint Halo |
| Partner: Zaneen |
| Division: Design |
| Installation: Surface |
| Product Type: Ceiling Surface |
| Mounting Location: Ceiling |
| Light Distribution: Downlight |

PHYSICAL

| |
|--|
| Aperture Sizes - Downlights: 1" |
| Shape: Cylinder |
| Diameter (mm): 80 |
| Diameter (in): 3 1/8" |
| Height (mm): 520 |
| Height (in): 20 1/2" |
| Fixture Finish: BLK / BRZ / IND |
| Holder Finish: BLK / BRZ / IND / WHI |
| Fixture Material: Aluminum |
| Upon Request: Cylinder height. Max. 1830 mm / 72". Min 153mm / 6". Min. qty required 50 pcs. |

ELECTRICAL

| |
|---|
| Lamp Type: LED |
| Input Wattage (W): 3.65 |
| Total Output Wattage (W): 2.7 |
| Dimming: Non-Dimmable |
| Driver Included: Yes |
| Driver Location: Integrated |
| Driver Type: Constant Current - Universal |
| Driver Class: Class 2 |
| Input Voltage (V): 120 - 277 |
| Constant Current (MA): 700 |
| Upon Request: (Not included - see components) Remote: Phase dimming @120Vac only / 0-10Vdc dimming (dimming requires min. 3 fixtures) |

LED

| |
|---|
| Number of LEDs: 1 |
| Color Temperature (°K): 3000 / 4000 |
| Nominal Lumen (lm): 124 / 133 |
| CRI: >90 CRI |
| Lamp Life (hrs): 50000 |
| Upon Request: 3500K |

OPTICAL

| |
|--|
| Optic°: 12 / 28 / 44 |
|--|

RATINGS AND CERTIFICATIONS

| |
|--|
| Certified By: Certified for North American Standards |
| IP rating: IP41 (Damp) |
| Upon Request: Damp Rated for Exterior |

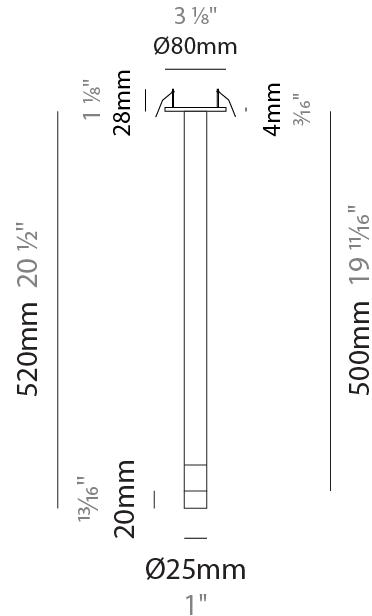
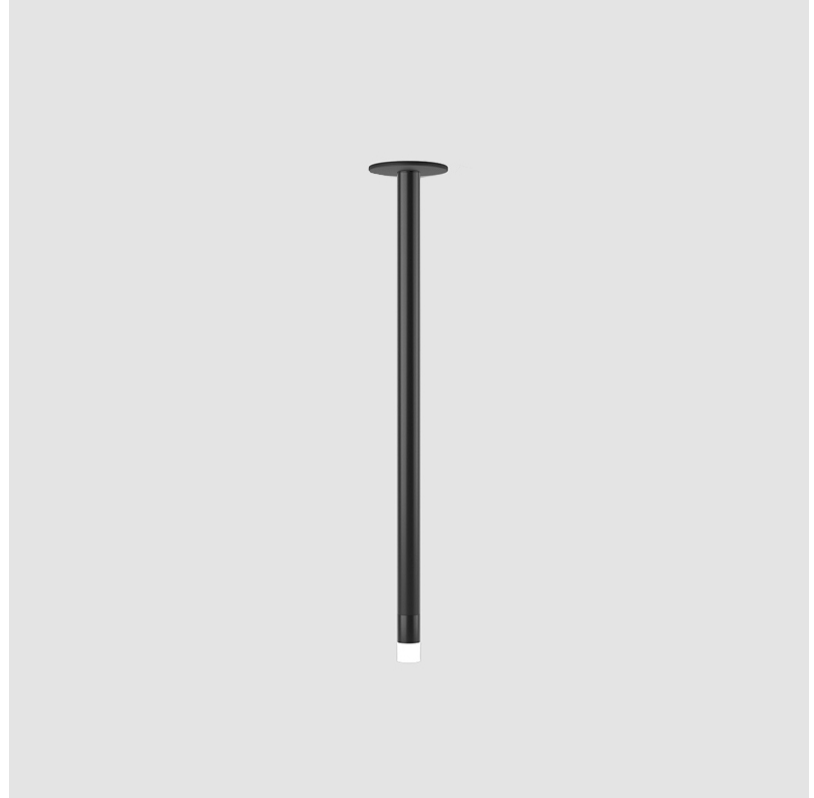

METROPOLIS MONOPOINT HALO SURFACE

D202006-

PROJECT

TYPE

SPECIFIER

QUANTITY

DATE

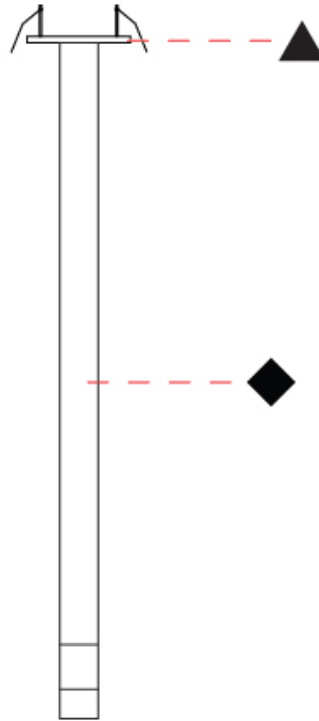

D

METROPOLIS MONOPOINT HALO SURFACE

D202007-

base number Color Finish Finish Lens
 Temperature (Diamond) (Triangle) Options

- To build a product code in our configurator select the specify button on the base model # product page
- To build a manual product code on this datasheet choose from the options listed below in blue font and add the suffix to the base model #

GENERAL

Series: Metropolis
 Subseries: Metropolis Monopoint Halo
 Partner: Zaneen
 Division: Design
 Installation: Surface
 Product Type: Ceiling Surface
 Mounting Location: Ceiling
 Light Distribution: Downlight

PHYSICAL

Aperture Sizes - Downlights: 1"
 Shape: Cylinder
 Diameter (mm): 80
 Diameter (in): 3 1/8"
 Height (mm): 820
 Height (in): 32 5/16"
 Fixture Finish: [BLK / BRZ / IND](#)
 Holder Finish: [BLK / BRZ / IND / WHI](#)
 Fixture Material: Aluminum
 Upon Request: Cylinder height. Max. 1830 mm / 72". Min 153mm / 6".
 Min. qty required 50 pcs.

ELECTRICAL

Lamp Type: LED
 Input Wattage (W): 3.65
 Total Output Wattage (W): 2.7
 Dimming: Non-Dimmable
 Driver Included: Yes
 Driver Location: Integrated
 Driver Type: Constant Current - Universal
 Driver Class: Class 2
 Input Voltage (V): 120 - 277
 Constant Current (MA): 700
 Upon Request: (Not included - see components) Remote: Phase dimming @120Vac only / 0-10Vdc dimming (dimming requires min. 3 fixtures)

LED

Number of LEDs: 1
 Color Temperature (°K): [3000 / 4000](#)
 Nominal Lumen (lm): 124 / 133
 CRI: >90 CRI
 Lamp Life (hrs): 50000
 Upon Request: 3500K

OPTICAL

Optic°: [12 / 28 / 44](#)

RATINGS AND CERTIFICATIONS

Certified By: Certified for North American Standards
 IP rating: IP41 (Damp)
 Upon Request: Damp Rated for Exterior

| |
|-----------|
| PROJECT |
| TYPE |
| SPECIFIER |
| QUANTITY |
| DATE |

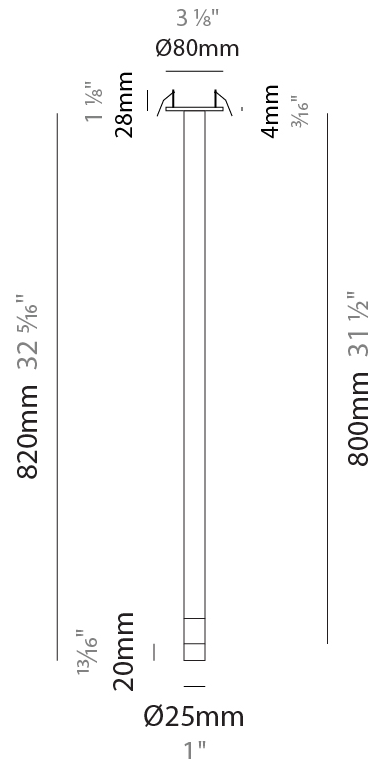
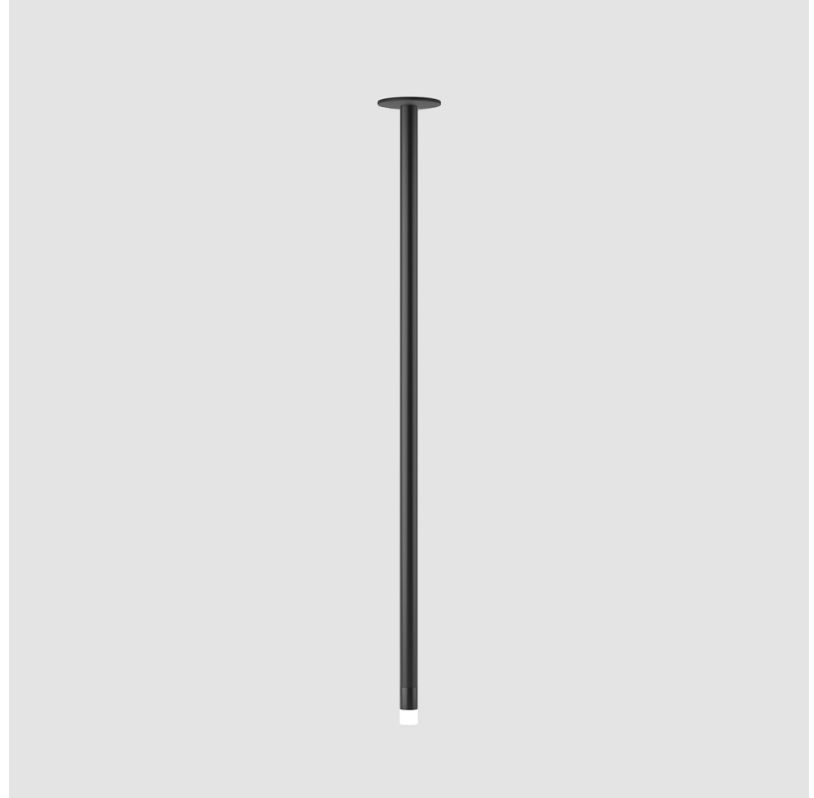

METROPOLIS MONOPOINT HALO SURFACE

D202007-

PROJECT

TYPE

SPECIFIER

QUANTITY

DATE

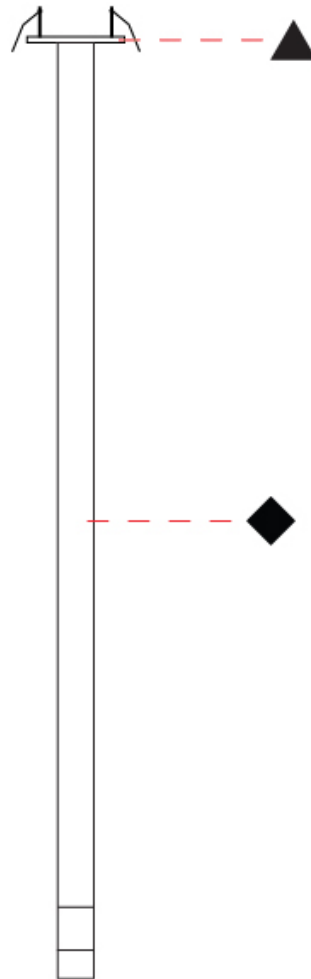

D

| | |
|-----------|-------|
| PROJECT | _____ |
| TYPE | _____ |
| SPECIFIER | _____ |
| QUANTITY | _____ |
| DATE | _____ |

Fixture Finish

Black - BLK

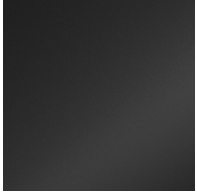

Bronze - BRZ

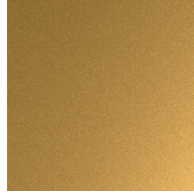

Industrial - IND



Holder Finish

Black - BLK

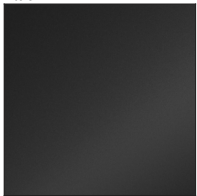

Bronze - BRZ

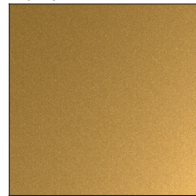

Industrial - IND

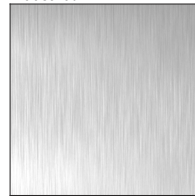

White - WHI



Digital: Not all screens are calibrated the same, and therefore, colors will appear differently between screens.

Physical: When texture is involved, there will be variations in color, character and tone within a product series and between product families.



LEGEND

| | | | | | |
|--|---|---|--|---|--|
|  | floor-mounted |  | pivotal |  | special LED (upon request) RGB, RGBW, tunable, gold+, meat+, art+, fashion+ |
|  | wall and ceiling: recessed and surface mounted |  | rotating |  | warm dim / natural dimming LED |
|  | ceiling-mounted and wall-mounted |  | illuminate tilted |  | rechargeable battery powered |
|  | wall-mounted |  | color of suspension cable |  | fixture with natural vivid LED (upon request) |
|  | omni-directional light distribution |  | length of suspension cable |  | color rendering index |
|  | direct light distribution |  | reflector degree selection |  | color temperature |
|  | direct/indirect light distribution |  | super spot |  | lumen (luminous flux) |
|  | indirect light distribution |  | lens |  | efficacy (lumens per watt) |
|  | asymmetric light distribution |  | lens pack |  | Unified Glare Rating (UGR) range from 5-40 |
|  | aura light distribution |  | shine ring |  | marine grade (AISI 316 stainless steel) |
|  | round wall or ceiling cut-out |  | integrated shine ring with diffuser |  | walk on |
|  | square wall or ceiling cut-out |  | free individual colors 01-29 |  | drive on |
|  | the supplied jig specifies the cutout dimensions |  | individual colors: 00 (free of charge), 01-25 (extra charge) |  | Dark Sky Compliance |
|  | minimum distance (meters) lamp - object |  | luminaire part to be colored (F1) |  | Americans with Disabilities Act (less than 4" off the wall located between 27"-84" from floor) |
|  | recessed depth |  | luminaire part to be colored (F2) |  | lamp protected against explosion |
|  | ceiling thickness in mm |  | luminaire part to be colored (F3) |  | blown glass using traditional methods by master glass blower |
|  | ceiling thickness selection |  | luminaire part to be colored (F4) |  | acoustic material |
|  | dimnable DP (phase), DV (0-10V), DD (dali), DS (step-dim) |  | luminaire part to be colored (F5) |  | protection class I, protection insulation |
|  | included or excluded LED driver/transformer/control gear |  | color of 3-circuit adaptor |  | protection class II, protection insulation |
|  | separately switchable |  | indirect diffuser |  | ETL Certified to UL and CSA Standards |
|  | sensor |  | direct diffuser |  | UL Certified to UL and CSA Standards |
|  | remote control |  | ball-proof (upon request) |  | CSA Certified to UL and CSA Standards |
|  | available upon request |  | accessory |  | Certified for North American Standards |

IP RATING

| | |
|---|--|
|  | protected against ingress of solid bodies greater than 12.5mm (finger) |
|  | protected against ingress of solid bodies greater than 2.5mm protected against sprays of water up to 60 degrees from the vertical (rain) |
|  | protected against ingress of solid bodies greater than 1mm (wire) no protection against the ingress of moisture |
|  | protected against ingress of solid bodies greater than 1mm (wire) protected against sprays of water up to 60 degrees from the vertical (rain) |
|  | protected against ingress of solid bodies greater than 1mm (wire) protected against water splashed from all directions |
|  | protected against limited ingress of dust (wet rooms/covered outdoor areas) protected against water splashed from all directions |
|  | protected against ingress of dust protected against jets of water |
|  | protected against ingress of dust protected against powerful jets of water or heavy seas |
|  | protected against ingress of dust protected against immersion of water between 15cm - 1m for 30 minutes |
|  | protected against ingress of dust protected against immersion of water under pressure for long periods |

IK RATING

| | |
|---|---|
|  | protected against 0.14 joules impact (equivalent to 0.25kg mass dropped from 56mm above the surface) |
|  | protected against 0.2 joules impact (equivalent to 0.25kg mass dropped from 80mm above the surface) |
|  | protected against 0.35 joules impact (equivalent to 0.25kg mass dropped from 140mm above the surface) |
|  | protected against 0.5 joules impact (equivalent to 0.25kg mass dropped from 200mm above the surface) |
|  | protected against 0.7 joules impact (equivalent to 0.25kg mass dropped from 280mm above the surface) |
|  | protected against 1 joules impact (equivalent to 0.25kg mass dropped from 400mm above the surface) |
|  | protected against 2 joules impact (equivalent to 0.5kg mass dropped from 400mm above the surface) |
|  | protected against 5 joules impact (equivalent to 1.7kg mass dropped from 300mm above the surface) |
|  | protected against 10 joules impact (equivalent to 5.0kg mass dropped from 200mm above the surface) |
|  | protected against 20 joules impact (equivalent to 5.0kg mass dropped from 400mm above the surface) |